



Fowler[®]
HIGH PRECISION

TOOL-A-THON

VOL 25.1 - VALID 1/1 - 4/30

FOWLER CUSTOMER SHOWCASE

 **TURNAMICS, INC.**
BICYCLE COMPONENT MAKER

FOWLERPRECISION.COM



Industry Nine bicycle hub by Turnamics

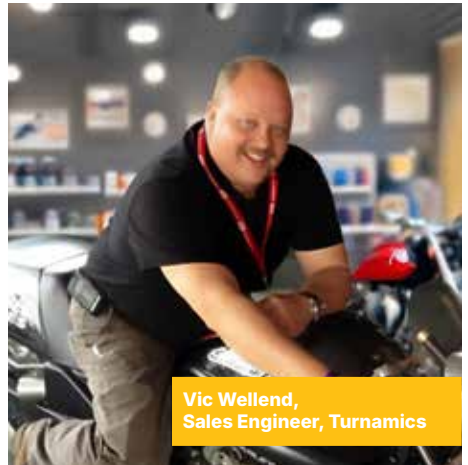

Vic Welland,
Sales Engineer, Turnamics

“This is the machine I’ve been waiting for my entire career!”

said Vic Welland, a veteran machine shop engineer and operations guru at Turnamics, when describing

Fowler’s zCAT Portable Coordinate Measuring Machine (CMM). Vic discovered the zCAT at IMTS in 2018. As Vic walked the show floor, the zCAT demo stopped him in his tracks. He marched over, demanding, “Do that again!” Vic had to see the “Touch & Teach” feature one more time.

The zCAT’s principle is that you create the measurements, and the software learns and records your moves. Then, you just hit ‘play’, and the machine will repeat your measurement path exactly.

When Vic saw the zCAT in action, he knew it was very different from traditional CMMs. He pictured using it in his Asheville, North Carolina shop, where his team of 40 makes parts for bicycle, transit, and telecommunications industries.

Vic finds training staff on the zCAT to be easy & quick: “I can take anybody off the floor, give them a ten-minute crash course, and they can check parts.”

The company now uses both a zCAT and a Axiom II with the same “Touch & Teach” feature. Vic values the zCAT’s ease of use, reliability, and creative workflows - He’s cleverly created his own daisy-chain jigs so that parts can be swapped out continuously while the zCAT keeps humming along.

Check out turnamics.com and industrynine.com to see what Vic and the crew at Turnamics produce. To learn more about the Fowler zCAT Portable CMM go to <https://bit.ly/40UPMHb>





zCAT Portable CMM

Features:

- Compact for use at the machine center
- Accuracy: MPEE 0.0003"/0.008mm
- "Touch & teach" software programmability w/ Fusion
- Completely portable, only 30 lbs.
- Ethernet communication (Bluetooth optional)

Order No. 54-950-001-0



Axiom Too

The complete inspection system.

Features:

- Short learning curve and compact footprint
- Y-axis options from 600mm to 1500mm
- Workshop-friendly with vibration protection
- Friction-free air bearings, aluminum bridge, and granite table



ABERLINK 
Innovative Metrology



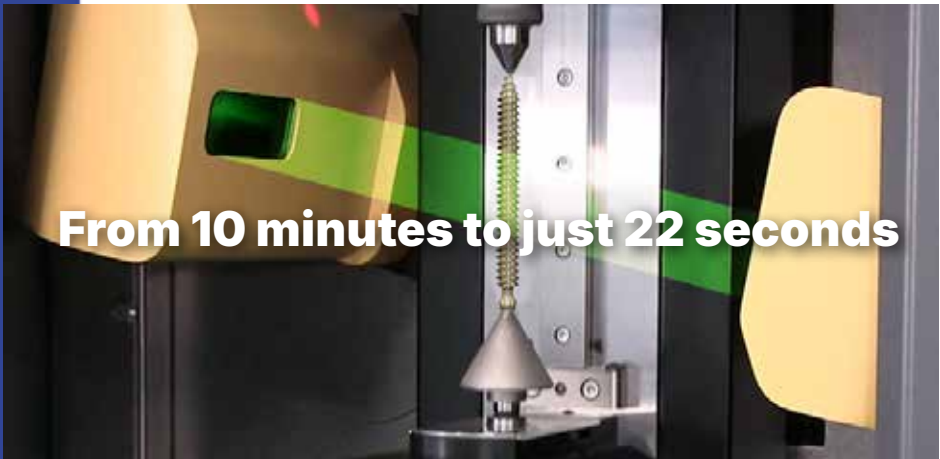

From 10 minutes to just 22 seconds

Precision at Lightning Speed: Transforming Medical Manufacturing

In medical technology, strict quality standards require precise inspections, often taking considerable time and cost. Brüttsch/Rüeggger Tools implemented the Sylvac-SCAN S25T, an optical, non-contact measuring system, at a Swiss manufacturer of bone screws and drills to streamline this process. The fully automated system reduced the inspection time from 10 minutes to just 22 seconds, achieving a 96% time savings and eliminating the need for multiple manual tools and logging steps.

The Sylvac-SCAN S25T consolidates dimensional accuracy checks into a fast, non-contact measurement that logs and archives data digitally, saving 8,027 hours annually and paying for itself in six months. Brüttsch/Rüeggger also offers ongoing support, training, and maintenance, ensuring reliable performance. This solution proves to be an efficient investment for maintaining precision in medical manufacturing.

Systems

See it in ACTION!

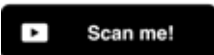

Fowler

SCAN S25T

Fast, Accurate, Reliable
& Repeatable!



Automation



READY!



Order No. 54-902-025-5

Features:

- Ideal for small cylindrical parts
- Measuring range: 1.02"/26mm Diameter, 7.87"/200mm Length
- High resolution and high accuracy
- One-click rapid measuring
- 30° tilting optics for complete thread measurements

The BEST Solution for Shaft Scanning!

Increase productivity while reducing scrap and inspection cycle times by a factor of 10 with the SCAN Family line-up.



Automation



READY!



Prices & Specifications are subject to change without notice.







Order No. 54-960-400-0

Part Inspection with Touch Mode or Scanning Mode

Features:

- Small footprint allowing measurements right next to your machine
- Intuitive software, allows quick and easy measurement
- Minimal setup
- Programmable magnetic soft buttons allow you to quickly change between software features without using a mouse
- Magnetic fixture templates allow you to quickly fix your part
- Volumetric accuracy of 0.0002"/0.005mm
- Uses a single USB cable to connect and requires no air

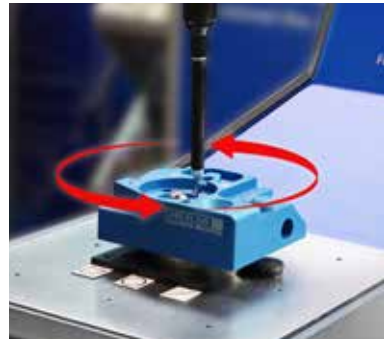

Rapid Measuring Systems

25.1

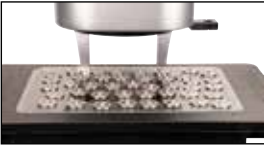

Measures multiple parts simultaneously



One touch measuring

5000
Up to 5000
dimensions

1024
Up to 1024
workpieces

2
Finish
measurements
in 2 seconds



Order No. 54-830-830-0

Features:

- Simultaneous measuring up to 100 parts
- Simple place and press measurement finish in 3 seconds
- No more operator errors
- Powerful yet easy to use measuring software
- Up to 12" x 8" field of view
- High resolution: 0.00004"/0.0001mm
- Accuracy: 0.00006"-0.0002"/0.0015mm-0.005mm

| Order No. | Measuring Range |
|--------------|-----------------|
| 54-830-310-0 | 100mm x 200mm |
| 54-830-320-0 | 200mm x 200mm |
| 54-830-830-0 | 300mm x 200mm |

Call for more information, 1-800-788-2353!

Horizontal Setting and Calibration

Setting of measuring equipment with variable dimensions.

HC5



Features:

- Designed for the calibration of fixed and variable measuring equipment
- Available in sizes up to 120"
- Adjustable measuring force

Order No. 54-197-370-0

HS6



Features:

- For setting equipment with variable dimensions quickly and accurately
- Available in sizes up to 120"
- Large selection of accessories to handle any job

Order No. 54-196-900-5



Systems



Fowler Trimos V Series Electronic Height Gages

The Fowler Trimos V series vertical measuring instruments have been developed for the most difficult shop floor environments. Manufactured in Switzerland, they guarantee precise and repeatable measurements with superior ease of use.



54-192-340-0



54-191-440-2D



NEW V4+

Features:

- Our most affordable 2D height gage
- Simple and easy-to-use graphic interface
- Highly efficient inspection
- Electronically adjustable measuring force



Features:

- Measures ID/OD, centerlines, heights, widths, depths, min/max/delta, slots, grooves and more!
- Electronically adjustable measuring force 0.75/1.5 (N)
- Lithium-ion rechargeable batteries last up to 40 hours
- Bluetooth transmitter available

All models Include:

- Charging unit
- Measuring probe with ruby ball Ø4mm
- Probe holder elbow Ø 8mm
- Setting gage





54-199-570-0



54-199-770-0

| Order No. | Range | Range with Probe Inverted | List Price |
|--------------------|--|---------------------------|-------------|
| V3 | | | |
| 54-192-340-0 | 16"/407mm | 20"/508mm | \$5,419.97 |
| 54-192-370-0 | 28"/711mm | 31.9"/812mm | \$5,511.60 |
| V4 | | | |
| 54-191-440-0 | 16"/407mm | 28.3"/719mm | \$6,584.83 |
| 54-191-470-0 | 28"/711mm | 40.2"/1023mm | \$8,305.31 |
| NEW V4+ | | | |
| 54-191-440-2D | 16"/407mm | 28.3"/719mm | \$8,600.00 |
| 54-191-470-2D | 28"/407mm | 40.2"/1023mm | \$8,990.00 |
| V5 | | | |
| 54-199-540-0 | 16"/407mm | 28.3"/719mm | \$7,257.35 |
| 54-199-570-0 | 28"/711mm | 40.2"/1023mm | \$8,600.23 |
| 54-199-590-0 | 43.7"/1110mm | 56"/1422mm | \$13,583.85 |
| V7 | | | |
| 54-199-740-0 | 16"/407mm | 28"/719mm | \$11,963.78 |
| 54-199-770-0 | 28"/711mm | 40"/1023mm | \$12,781.27 |
| 54-199-790-0 | 44"/1100mm | 56"/1422mm | \$18,311.10 |
| Probe Sets | | | |
| 54-199-105-0 | 4mm Probe Set, 21 piece | | \$1,923.23 |
| 54-199-106-0 | 8mm Probe Set, 16 piece | | \$1,556.00 |
| 54-199-107-0 | 8mm Basic Probe Set, 7 piece | | \$509.53 |
| Accessories | | | |
| 54-199-400-0 | 12"/300mm Holder - for 8mm probes | | \$1,167.27 |
| 54-199-022-BT | Bluetooth transmitter (Not available for V3 models) | | \$675.79 |
| 54-777-120-0 | Vmx software - for connecting multiple units to one PC | | \$565.47 |

Fowler Sylvac Hi_Cal V2 Electronic Height Gages

For your finer, more delicate parts.

Features:

- **Bluetooth for quick, easy recorded measurements**
- Extra low measuring force, from 0.2N
- Measure internal and external diameters, centerlines, heights, widths, depths and MIN/MAX/TIR capability
- Battery life: 40 hours rechargeable during operation
- Touch sensitive probe speed for easy operation
- Base with small footprint

FREE 1mm Ball Probe
with 6"/150mm and 12"/300mm Hi_Cal Purchase!



- All models include:**
- Protective cover
 - Charging set
 - Ruby ball probe Ø3mm
 - Setting gage

FREE Basic Probe Set

with 54-931-450-BT Hi_Cal Purchase
\$951.03 Value!



| Order No. | Range | Accuracy | List Price |
|--------------------|-----------------|-------------------|------------|
| 54-931-150-BT | 6"/150mm | 0.00013"/0.0034mm | \$5,900.00 |
| 54-931-300-BT | 12"/300mm | 0.00016"/0.0042mm | \$6,500.00 |
| 54-931-450-BT | 17.5"/450mm | 0.00020"/0.005mm | \$7,300.00 |
| Accessories | | | |
| 54-930-215-0 | Full Probe Set | | \$1,771.05 |
| 54-930-217-0 | Basic Probe Set | | \$951.03 |

NEW V1 & V1+ Electronic Height Gages

Introducing the next generation of Trimos entry-level height gages for the workshop.

Features:

- Accuracy: 0.0012"/0.03mm
- Bluetooth/RS232 data output
- Steel base and extra large display with simplified keypad
- V1 features a fine adjust hand-wheel for scribing (scraper included)
- V1+ features bi-directional measuring force hand-wheel for measuring bores, centerlines, heights, min/max/delta. Supplied with 0.236"/6mm ball probe



FREE

Swiss Army knife with purchase!



Online registration required



TRIMOS



**SWISS
MADE**



54-180-412-0

54-180-524-5

| Order No. | Description | Range | Resolution | List Price |
|--------------|------------------------|-----------|-----------------|------------|
| 54-180-412-0 | V1 | 12"/306mm | 0.001"/0.01mm | \$2,529.99 |
| 54-180-424-0 | V1 | 24"/611mm | 0.001"/0.01mm | \$3,299.99 |
| 54-180-512-0 | V1+ | 12"/306mm | 0.0001"/0.001mm | \$3,519.99 |
| 54-180-512-5 | V1+ w/Granite Base | 12"/306mm | 0.0001"/0.001mm | \$4,069.99 |
| 54-180-524-0 | V1+ | 24"/611mm | 0.0001"/0.001mm | \$4,399.99 |
| 54-180-524-5 | V1+ w/Granite Base | 24"/611mm | 0.0001"/0.001mm | \$4,949.99 |
| Accessory | | | | |
| 54-194-904-0 | Scraper for V1 and V1+ | | | \$157.50 |

Z-HEIGHT Height Gage

With handwheel and fine adjust.

Features:

- Range: 18"/450mm
- Accuracy: $\pm 0.002"/0.05$ mm
- Resolution 0.0005"/0.01mm
- Base design has a more comfortable grip and is finely ground and lapped for smooth movement on surface plates
- Fine adjust feature allows precise adjustment to required settings
- Indicator holding bar included

24" Height Gage shown

Order No. 54-175-018-0

Sale \$650.00

List Price \$730.98

Z-HEIGHT ABS PLUS+ Height Gage

Features:

- Range: 12"/300mm
- Accuracy: $\pm 0.002"/0.05$ mm
- Resolution 0.0005"/0.01mm
- True ABS measuring system
- Supplied with a NIST certified test block (1" x 2" x 3")
- Supplied with mini USB data cable
- Carbide scriber
- Positive locking level for scriber
- Can be used with wireless transmitter (54-115-100-0)

Order No. 54-175-012-1

Sale \$649.00

List Price \$745.43

Fowler Bowers **BLUETOOTH**



XTH3 Bluetooth Holematic Pistol Grips

Features:

- Coolant proof, dust proof - IP67
- Resolution: 0.00005"/0.001mm
- Bluetooth connectivity to your phone or tablet
- Accuracies: 0.00015" - 0.00035"/0.004mm - 0.009mm
- Tungsten carbide measuring faces on all 3-point heads from 0.5"/12.5mm and up
- Sizes over 0.500"/12.5mm feature blind bore capability
- Includes UKAS certificates for all pistol grip, heads and rings
- Additional individual sizes available

**For special application heads, contact the
Fowler Technical Department 1-800-788-2353**



54-567-100-BT



2 and 3 Point
Grooves



3 Point Spherical



Ball Screw
Threads



| Order No. | Range | Includes | List Price |
|-------------------------------|--|----------------------------|------------|
| Pistol Grip Complete Sets | | | |
| 54-567-009-BT | 0.080" - 0.250"/2 - 6mm (2 pt.) | 5 heads, 1 handle, 3 rings | \$7,033.38 |
| 54-567-010-BT | 0.250" - 0.375"/6 - 10mm | 2 heads, 1 handle, 1 ring | \$2,757.87 |
| 54-567-020-BT | 0.375" - 0.750"/10 - 20mm | 3 heads, 1 handle, 2 rings | \$3,226.40 |
| 54-567-050-BT | 0.750" - 2"/20 - 50mm | 3 heads, 1 handle, 2 rings | \$4,165.94 |
| 54-567-100-BT | 2" - 4"/50 - 100mm | 3 heads, 1 handle, 2 rings | \$4,636.93 |
| 54-567-105-BT | 4" - 6"/100 - 150mm | 2 heads, 1 handle, 1 ring | \$4,165.94 |
| 54-567-110-BT | 6" - 8"/150 - 200mm | 2 heads, 1 handle, 1 ring | \$5,498.92 |
| 54-567-200-BT | 4" - 8"/100 - 200mm | 4 heads, 1 handle, 2 rings | \$8,703.75 |
| 54-567-210-BT | 0.750" - 4"/20 - 100mm | 6 heads, 1 handle, 4 rings | \$5,091.00 |
| 54-567-620-BT | 0.250" - 0.750"/6 - 20mm | 5 heads, 1 handle, 3 rings | \$3,722.00 |
| Connectivity Cables/Accessory | | | |
| 54-115-526-0 | Proximity cable with USB connection | | \$234.54 |
| 54-115-527-0 | Proximity cable with serial connection | | \$227.10 |
| 54-115-246-BT | USB bluetooth receiver | | \$51.92 |

Extensions

| Order No. | Length | Diameter | Fits Heads | List Price |
|--------------|------------|----------|-----------------------------|------------|
| 54-336-301-0 | 2.5"/63mm | 0.230" | 0.250"-0.375"/6-10mm | \$175.56 |
| 54-336-302-0 | 3"/76mm | 0.366" | 0.375"-0.500"/10-12.5mm | \$175.56 |
| 54-336-303-0 | 4"/100mm | 0.479" | 0.500"-0.750"/12.5-20mm | \$175.56 |
| 54-336-304-0 | 5"/127mm | 0.740" | 0.750"-2"/20-50mm | \$268.65 |
| 54-336-305-0 | 6"/150mm | 0.924" | 2" and up (50mm and higher) | \$287.20 |
| 54-336-306-0 | 20"/500mm | 0.757" | 0.750" and higher | \$908.15 |
| 54-336-307-0 | 40"/1000mm | 1.365" | 1.375" and higher | \$1,345.40 |

Bore Gaging Systems



XTD3 Bluetooth Electronic Holey Mikes

Features:

- Coolant proof, dust proof - IP67
- Resolution: 0.00005"/0.001mm
- Bluetooth connectivity to your phone or tablet
- Accuracies: 0.00015" - 0.00035"/0.004mm - 0.009mm
- Tungsten carbide measuring faces on all 3-point heads from 0.5"/12.5mm and up
- Sizes over 0.500"/12.5mm feature blind bore capability
- Includes UKAS certificates for all pistol grip, heads and rings
- Additional sizes available



54-367-020-BT

For special application heads, contact the
Fowler Technical Department 1-800-788-2353



| Order No. | Range | Includes | List Price |
|--|--|----------------------------|------------|
| Holey Mike Complete Sets (Traditional style) | | | |
| 54-367-000-BT | 0.080" - 0.250"/2 - 6mm (2 pt.) | 5 heads, 1 handle, 3 rings | \$4,545.20 |
| 54-367-010-BT | 0.250" - 0.375"/6 - 10mm | 2 heads, 1 handle, 1 ring | \$2,670.76 |
| 54-367-020-BT | 0.375" - 0.750"/10 - 20mm | 3 heads, 1 handle, 2 rings | \$3,187.03 |
| 54-367-050-BT | 0.750" - 2"/20 - 50mm | 3 heads, 1 handle, 2 rings | \$4,326.12 |
| 54-367-100-BT | 2" - 4"/50 - 100mm | 3 heads, 1 handle, 2 rings | \$4,791.89 |
| 54-367-105-BT | 4" - 6"/100 - 150mm | 2 heads, 1 handle, 1 ring | \$3,818.10 |
| 54-367-110-BT | 6" - 8"/150 - 200mm | 2 heads, 1 handle, 1 ring | \$5,034.70 |
| 54-367-200-BT | 4" - 8"/100 - 200mm | 4 heads, 1 handle, 2 rings | \$8,332.50 |
| Connectivity Cables/Accessory | | | |
| 54-115-526-0 | Proximity cable with USB connection | | \$234.54 |
| 54-115-527-0 | Proximity cable with serial connection | | \$227.10 |
| 54-115-246-BT | USB bluetooth receiver | | \$51.92 |

Extensions

| Order No. | Length | Diameter | Fits Heads | List Price |
|--------------|------------|----------|-----------------------------|------------|
| 54-336-301-0 | 2.5"/63mm | 0.230" | 0.250"-0.375"/6-10mm | \$175.56 |
| 54-336-302-0 | 3"/76mm | 0.366" | 0.375"-0.500"/10-12.5mm | \$175.56 |
| 54-336-303-0 | 4"/100mm | 0.479" | 0.500"-0.750"/12.5-20mm | \$175.56 |
| 54-336-304-0 | 5"/127mm | 0.740" | 0.750"-2"/20-50mm | \$268.65 |
| 54-336-305-0 | 6"/150mm | 0.924" | 2" and up (50mm and higher) | \$287.20 |
| 54-336-306-0 | 20"/500mm | 0.757" | 0.750" and higher | \$908.15 |
| 54-336-307-0 | 40"/1000mm | 1.365" | 1.375" and higher | \$1,345.40 |

Prices & Specifications are subject to change without notice.

XT-Series Holemikes

Vernier Bore Micrometers.



Features:

- 3-pt contact with tungsten carbide measuring anvils above 0.5"
- Blind bore measuring heads featured above 0.5"
- Ratchet stop for consistent measuring
- Extensions available for deep measuring
- Includes UKAS certificates for all Holemikes and setting rings

| Order No. | Range | Grads. | Measuring Accuracy | Measuring Depth | Ring Included | List Price |
|--------------|-----------------|-----------------------------|--------------------|-----------------|---------------|------------|
| 52-255-310-0 | 0.250" - 0.312" | 0.00025" | 0.00015" | 2.28" | 0.312" | \$829.07 |
| 52-255-311-0 | 0.312" - 0.375" | 0.00025" | 0.00015" | 2.28" | 0.312" | \$767.67 |
| 52-255-312-0 | 0.375" - 0.500" | 0.00025" | 0.00015" | 2.28" | 0.5" | \$767.67 |
| 52-255-313-0 | 0.500" - 0.625" | 0.00025" | 0.00015" | 2.44" | 0.5" | \$767.67 |
| 52-255-314-0 | 0.625" - 0.750" | 0.00025" | 0.00015" | 2.44" | 0.75" | \$787.25 |
| 52-255-315-0 | 0.750" - 1" | 0.00025" | 0.00015" | 2.60" | 0.75" | \$864.56 |
| 52-255-316-0 | 1" - 1.375" | 0.00025" | 0.00015" | 2.60" | 1.375" | \$1,231.87 |
| 52-255-317-0 | 1.375" - 2" | 0.00025" | 0.00015" | 3.15" | 1.375" | \$1,261.24 |
| 52-255-318-0 | 2" - 2.625" | 0.00025" | 0.0002" | 3.15" | 2.625" | \$1,504.52 |
| 52-255-319-0 | 2.625" - 3.250" | 0.00025" | 0.0002" | 3.15" | 2.625" | \$1,517.98 |
| 52-255-320-0 | 3.250" - 4" | 0.00025" | 0.0002" | 3.94" | 3.25" | \$1,893.75 |
| 52-255-321-0 | 4" - 5" | 0.00025" | 0.00025" | 4.53" | 5" | \$1,975.15 |
| 52-255-322-0 | 5" - 6" | 0.00025" | 0.00025" | 4.53" | 5" | \$2,291.54 |
| Sets | | | | | | |
| 52-255-565-0 | 0.250" - 0.375" | 2 heads, 2 handles, 1 ring | | | | \$1,686.00 |
| 52-255-665-0 | 0.375" - 0.750" | 3 heads, 3 handles, 2 rings | | | | \$2,096.32 |
| 52-255-775-0 | 0.750" - 2" | 3 heads, 3 handles, 2 rings | | | | \$3,293.82 |
| 52-255-890-0 | 4" - 6" | 2 heads, 2 handles, 1 ring | | | | \$3,137.31 |
| 52-255-900-0 | 6" - 8" | 2 heads, 2 handles, 1 ring | | | | \$4,917.38 |

XTENDER Electronic Bore Gage Set

with Carbide Anvils

Industry's two most popular bore gage ranges combined in one easy-to-use electronic set!

Preset size of master for absolute reading and use minimum hold feature to lock on the bore size as the gage is rocked in the part to be measured.



Bore Gage features:

- Range: 1.4"-6"/35mm-150mm
- Accuracy: 0.0006"/0.015mm
- Carbide anvils
- Self-centering

Indicator features:

- Bar graph for reversal point indication
- Preset with recall
- ABS/INC measurement
- Min/Max/TIR



| Order No. | Range | Resolution | List Price | Sale Price |
|-------------------|---------------------|------------------|------------|-----------------|
| 54-646-401-0 | 1.4 - 6"/35 - 150mm | 0.00005"/0.001mm | \$441.83 | \$358.00 |
| Extensions | | | | |
| 52-646-450-0 | 20" depth extension | | \$113.83 | \$98.00 |
| 52-646-475-0 | 40" depth extension | | \$127.91 | \$111.00 |

Dial Cylinder Bore Gages

2-point bore measuring.

Features:

- Carbide Anvils
- Easy-to-read
- Great value
- Graduation: 0.0005", 0.0001" or 0.01mm
- Insulated grip
- 9.5" depth above 1.5"
- Chrome plated handle

XTENDER



52-646-400-0



| Order No. | Range | Graduation | Accuracy | List Price | Sale Price |
|--------------|---------------------|--|----------|------------|-----------------|
| 52-646-100-0 | 0.7" - 1.5" | 0.0005" | 0.0009" | \$177.85 | \$149.00 |
| 52-646-300-0 | 2" - 6" | 0.0005" | 0.0009" | \$168.28 | \$137.00 |
| 52-646-400-0 | 1.4" - 6" | 0.0005" | 0.0009" | \$223.49 | \$180.00 |
| 52-646-500-0 | 1.4" - 6" | 0.0001" | 0.0005" | \$290.16 | \$235.00 |
| 52-646-220-0 | 35 - 60mm | 0.01mm | 0.02mm | \$291.27 | \$236.00 |
| Extensions | | | | | |
| 52-646-450-0 | 20" depth extension | <i>*Not for use with 52-646-100-0 or 500-0</i> | | \$113.83 | \$98.00 |
| 52-646-475-0 | 40" depth extension | <i>*Not for use with 52-646-100-0 or 500-0</i> | | \$127.91 | \$111.00 |

Internal & External Electronic Caliper Gages

For grooves and recesses.



54-554-611-0



54-554-711-0

Features:

- Accuracy: $\pm 0.0008"/\pm 0.02\text{mm}$
- Resolution: 0.0002"/0.005mm
- Analog scale for reversal point indication
- Large, LCD display
- Preset capability
- Absolute and incremental measurements modes
- High-impact, aircraft aluminum case
- Rugged housing

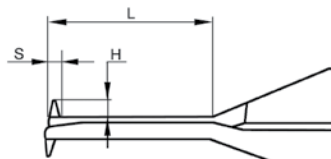

Dimensions for Internal Calipers

| Metric | Inch | L | S | H | Tip Radius |
|---------|----------|------|-------|-------|------------|
| 5-15mm | 0.2-0.6" | 20mm | 1.0mm | 1.5mm | 0.3mm |
| 5-25mm | 0.2-1.0" | 35mm | 1mm | 1.5mm | 0.3mm |
| 10-30mm | 0.4-1.2" | 55mm | 2mm | 3.5mm | 0.5mm |
| 20-40mm | 0.8-1.6" | 80mm | 3mm | 6.5mm | 0.5mm |
| 30-50mm | 1.2-2.0" | 80mm | 3mm | 8.5mm | 0.5mm |

Dimensions for External Calipers

| Metric | Inch | L | S | H | Tip Radius |
|---------|----------|------|-------|------|------------|
| 0-10mm | 0-0.4" | 40mm | 3mm | 8mm | 0.5mm |
| 0-20mm | 0-0.8" | 80mm | 6.5mm | 25mm | 0.75mm |
| 10-30mm | 0.4-1.2" | 80mm | 6.5mm | 25mm | 0.75mm |
| 20-40mm | 0.8-1.6" | 80mm | 6.5mm | 25mm | 0.75mm |
| 30-50mm | 1.2-2.0" | 80mm | 6.5mm | 25mm | 0.75mm |

| Order No. | Range | List Price | Sale Price |
|------------------------|--------------------------|------------|-----------------|
| Internal Caliper Gages | | | |
| 54-554-611-0 | 0.200" - 0.590"/5 - 15mm | \$217.89 | \$177.00 |
| 54-554-622-0 | 0.200" - 1"/5 - 25mm | \$233.61 | \$190.00 |
| 54-554-623-0 | 0.400" - 1.2"/10 - 30mm | \$244.52 | \$198.00 |
| 54-554-624-0 | 0.790" - 1.6"/20 - 40mm | \$279.85 | \$227.00 |
| 54-554-625-0 | 1.2" - 2"/30 - 50mm | \$279.85 | \$227.00 |
| External Caliper Gages | | | |
| 54-554-711-0 | 0 - 0.400"/0 - 10mm | \$249.35 | \$202.00 |
| 54-554-722-0 | 0 - 0.790"/0 - 20mm | \$267.36 | \$217.00 |
| 54-554-723-0 | 0.4" - 1.2"/10 - 30mm | \$279.85 | \$227.00 |
| 54-554-724-0 | 0.790" - 1.6"/20 - 40mm | \$279.85 | \$227.00 |
| 54-554-725-0 | 1.2" - 2"/30 - 50mm | \$244.52 | \$198.00 |

Prices & Specifications are subject to change without notice.

Swiss Ultralight IV Electronic Calipers

When you have HUGE parts to measure, this is the caliper you need!



sylvac

**SWISS
PRECISION**



Features:

- IP67 protected against fluid and dust
- Built-in Bluetooth
- Reinforced frame
- XXL display with 0.79"/20mm high digits
- Lengthened jaws 7.9"/200mm
- Includes upper ID measuring pins (5mm dia.)
- Movable left jaw
- Stainless steel titanium coated jaws
- Hold feature
- Preset function
- Min/Max functions
- Tolerance mode
- Internal and external measurement indicator

Alternative jaws available, contact the Fowler Technical Department for more information 1-800-788-2353

| Order No. | Range | Accuracy | List Price |
|---------------------------------|--|---------------------|------------|
| 54-110-512-0 | 0 - 15"/0 - 400mm | 0.0012"/30 μ m | \$2,659.53 |
| 54-110-524-0 | 0 - 24"/0 - 600mm | 0.0016"/40 μ m | \$3,167.70 |
| 54-110-540-0 | 0 - 40"/0 - 1000mm | 0.002"/50 μ m | \$3,648.07 |
| 54-110-560-0 | 0 - 60"/0 - 1500mm | 0.0035"/90 μ m | \$4,792.49 |
| 54-110-580-0 | 0 - 80"/0 - 2000mm - <i>special order</i> | 0.0048"/120 μ m | \$7,400.91 |
| 54-110-600-0 | 0 - 100"/0 - 2500mm - <i>special order</i> | 0.0078"/200 μ m | \$9,015.25 |
| Connectivity Cables/Accessories | | | |
| 54-981-713-2 | Sylcom Basic Data Processing Software | | \$851.22 |
| 54-115-526-0 | Proximity USB Cable | | \$234.54 |
| 54-115-527-0 | Proximity Serial Cable | | \$227.10 |
| 54-115-246-BT | USB Bluetooth Receiver | | \$51.92 |

Swiss Ultra-Cal VI Electronic Calipers

3 styles to suit your needs.



54-100-167-0



54-100-444-1



Easy Data Collection using Sylcom Software.

Features:

- IP67 protected against fluid and dust
- Available with Bluetooth, proximity cable or no SPC output
- Heavy duty frame (3.5mm)
- Extra large display
- Available with ISO Cert
- 12"/300mm is supplied without depth rod



| Order No. | Range | Accuracy | Resolution | List Price |
|---------------------------------|--|--------------|----------------|------------|
| Bluetooth Communication | | | | |
| 54-100-167-0 | 6"/150mm | 0.0008"/20µm | 0.0005"/0.01mm | \$446.33 |
| 54-100-168-0 | 8"/200mm | 0.0012"/30µm | 0.0005"/0.01mm | \$761.74 |
| 54-100-169-0 | 12"/300mm | 0.0012"/30µm | 0.0005"/0.01mm | \$930.57 |
| Proximity Cable Communication | | | | |
| 54-100-444-1 | 6"/150mm | 0.0008"/20µm | 0.0005"/0.01mm | \$205.87 |
| 54-100-448-1 | 8"/200mm | 0.0012"/30µm | 0.0005"/0.01mm | \$461.67 |
| 54-100-412-1 | 12"/300mm | 0.0012"/30µm | 0.0005"/0.01mm | \$622.71 |
| Without Data Output | | | | |
| 54-100-177-0 | 6"/150mm | 0.0008"/20µm | 0.0005"/0.01mm | \$177.64 |
| 54-100-178-0 | 8"/200mm | 0.0012"/30µm | 0.0005"/0.01mm | \$418.73 |
| 54-100-179-0 | 12"/300mm | 0.0012"/30µm | 0.0005"/0.01mm | \$483.07 |
| Connectivity Cables/Accessories | | | | |
| 54-981-713-2 | Sylcom Basic Data Processing Software | | | \$851.22 |
| 54-115-526-0 | Proximity cable with USB Connection | | | \$234.54 |
| 54-115-527-0 | Proximity cable with Serial Connection | | | \$227.10 |
| 54-115-246-BT | USB Bluetooth Receiver | | | \$51.92 |

Prices & Specifications are subject to change without notice.

Micron 0.0005" Electronic Caliper

HIGH Resolution and HIGH Accuracy.

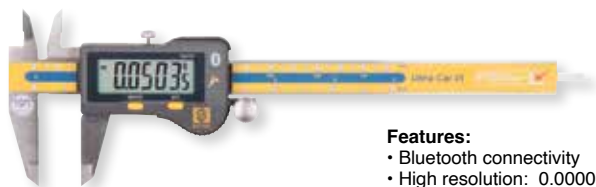

Fowler

LIFETIME WARRANTY



sylvac

SWISS
PRECISION



Features:

- Bluetooth connectivity
- High resolution: 0.0005"/0.001mm
- Accuracy up to 4": 0.0006"/0.015mm
- Accuracy above 4": 0.0012"/0.03mm
- Heavy duty frame (3.5mm)

| Order No. | Range | List Price |
|---------------|------------------------|------------|
| 54-100-100-0 | 0 - 6"/150mm | \$516.39 |
| Accessory | | |
| 54-115-246-BT | USB Bluetooth receiver | \$51.92 |

IP67 Electronic Calipers

Smart Wireless Communication to most phones or tablets.



54-100-556-BT

Features:

- IP67 protected against fluid and dust
- Wireless connectivity for quick error free data collection
- Supplied with NIST certification
- Heavy duty frame with 4-way measuring, inside, outside, depth and step
- Includes extra battery tray and a 1" setting standard

| Order No. | Range | Accuracy | List Price | Sale Price |
|---------------|---------------|----------------|------------|-----------------|
| 54-100-556-BT | 0 - 6"/150mm | 0.001"/0.02mm | \$221.80 | \$191.00 |
| 54-100-512-BT | 0 - 12"/300mm | 0.0015"/0.04mm | \$272.52 | \$234.00 |

XTRA-VALUE Plus Electronic Calipers

IP54 protected with inch/metric/fractions.



54-103-006-0

Features:

- Range: 6"/150mm
- Inch/Metric/Fraction reading: 0.0005"/0.01mm/ 1/128"
- Heavy Duty frame for extra rigidity and wear resistance
- Super large, easy to read display

| Order No. | Range | Accuracy | List Price | Sale Price |
|--------------|---------------|----------------|------------|-----------------|
| 54-103-006-0 | 0 - 6"/150mm | 0.001"/0.02mm | \$103.93 | \$80.00 |
| 54-103-012-0 | 0 - 12"/300mm | 0.0015"/0.03mm | \$160.28 | \$135.00 |



54-101-150-2



54-101-300-1

Features:

- Stainless steel frame
- Resolution: 0.0005"/0.01mm
- Absolute/Incremental measurement
- 4-way measuring, inside, outside, depth and step
- 6" and 12" regular display models include NIST Cert.



| Order No. | Range | Accuracy | List Price | Sale Price |
|--------------|---|----------------|------------|-----------------|
| 54-101-150-2 | 6"/150mm - Regular Display | 0.001"/0.02mm | \$57.68 | \$47.00 |
| 54-101-600-1 | 6"/150mm - Large Display with Hold feature | 0.0015"/0.04mm | \$79.40 | \$57.00 |
| 54-101-200-1 | 8"/200mm - Regular Display | 0.0015"/0.04mm | \$107.43 | \$87.00 |
| 54-101-300-1 | 12"/300mm - Regular Display | 0.0015"/0.04mm | \$131.75 | \$107.00 |
| 54-101-900-1 | 12"/300mm - Large Display with Hold feature | 0.0015"/0.04mm | \$173.83 | \$125.00 |

Caliper Accessory Set

Add greater versatility to your dial, vernier or electronic calipers.



Accessory Set includes:

- Set of clamps
- 4 sets of screws
- 1 set of ball contact points
- 1 set of flat contact points
- 1 set of point contact points
- 1 set of spline contact points
- 1 Allen wrench
- Plastic case

Features:

- For difficult applications and configurations or hard to reach places
- Fits most standard 4" - 8" calipers and light duty 12" calipers
- Measures inside, outside, step, grooves, left or right applications with just a few simple calculations

Order No. 52-010-005-0

Sale \$52.00

List Price \$63.22

XTRA-RANGE[®] Carbon Fiber Electronic Calipers



54-100-140-0

Features:

- IP65 protected against fluid and dust
- Lightweight carbon fiber frame
- Stainless steel jaws with ID nibs
- ID/OD pressure device for repeatability
- USB data output (works with 54-520-399-0)
- Preset, ABS/INC, Floating zero, IN/MM, Hold function
- Super large display
- Fitted wooden case

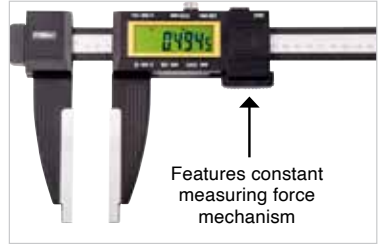

Features constant measuring force mechanism

| Order No. | Range | Accuracy | Jaw Depth | Weight | List Price | Sale Price |
|--------------|----------------|----------------|------------|-----------|------------|-------------------|
| 54-100-124-0 | 0 - 24"/600mm | 0.0020"/0.05mm | 5.4"/138mm | 2.85 lbs. | \$866.25 | \$743.00 |
| 54-100-140-0 | 0 - 40"/1000mm | 0.0025"/0.06mm | 5.4"/138mm | 3.45 lbs. | \$1,569.75 | \$1,346.00 |
| 54-100-160-0 | 0 - 60"/1500mm | 0.0055"/0.13mm | 5.9"/150mm | 4.4 lbs. | \$2,094.75 | \$1,796.00 |

XTRA-RANGE[®] Electronic Calipers

For large measurements

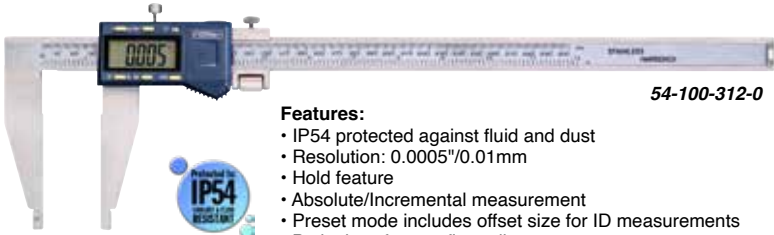

54-100-312-0

Features:

- IP54 protected against fluid and dust
- Resolution: 0.0005"/0.01mm
- Hold feature
- Absolute/Incremental measurement
- Preset mode includes offset size for ID measurements
- Both sizes feature fine adjustment



| Order No. | Range | Accuracy | Jaw Depth | List Price | Sale Price |
|--------------|----------------|------------------|-----------|------------|-------------------|
| 54-100-312-0 | 0 - 12"/300mm | ± 0.002"/0.05mm | 3.5" | \$280.01 | \$250.00 |
| 54-100-024-1 | 0 - 24"/600mm | ± 0.003"/0.075mm | 4" | \$433.59 | \$385.00 |
| 54-100-042-1 | 0 - 40"/1000mm | ± 0.004"/0.1mm | 4.9" | \$1,510.85 | \$1,295.00 |

XTRA-RANGE[®] Dial Calipers

With full length depth rod



52-008-018-0

Features:

- Graduations: 0.001"
- Jaw depth: 3.125"
- Stainless steel construction
- Satin chrome finish
- Full length depth rod
- 0.50" internal measuring nibs on jaws

| Order No. | Range | Accuracy | List Price | Sale Price |
|--------------|---------|----------|------------|-----------------|
| 52-008-018-0 | 0 - 18" | ± 0.003" | \$307.02 | \$245.00 |
| 52-008-024-0 | 0 - 24" | ± 0.003" | \$372.05 | \$315.00 |

Premium Grade Dial Calipers

With mono-block housing for added protection.

Purchase a 12" & Receive a 6" Free

Buy a 12" (52-008-712-0) at **list price** and get a 6" (52-008-706-0) **FREE**.

The mono-block housing design of this Premium Dial Caliper aids in preventing debris from entering the gearing mechanism. The covered rack aids in preventing debris from entering the rack. This helps to ensure years of continued service and accuracy.



52-008-706-0

Special Price!



52-008-707-0

Features:

- Tough shockproof gearing with ultra smooth movement
- 4-way measuring, inside, outside, depth and step
- Solid stainless steel construction with lapped measuring faces
- 0.100" range per revolution
- 0.001" reading dial, 0.100" range per revolution



| Order No. | Range | Dial Color | Accuracy | List Price | Sale Price |
|--------------|--|------------|-----------|------------|-----------------|
| 52-008-712-P | Buy a 12" (52-008-712-0) and Get a 6" (52-008-706-0) FREE | | | \$282.05 | \$174.17 |
| 52-008-704-1 | 0 - 4" | White | ± 0.001" | \$94.50 | \$77.00 |
| 52-008-714-1 | 0 - 4" | Black | ± 0.001" | \$94.50 | \$77.00 |
| 52-008-706-0 | 0 - 6" | White | ± 0.001" | \$107.88 | \$50.00 |
| 52-008-707-0 | 0 - 6" | Black | ± 0.001" | \$107.88 | \$75.00 |
| 52-008-708-0 | 0 - 8" | White | ± 0.0015" | \$129.54 | \$105.00 |
| 52-008-712-0 | 0 - 12" | White | ± 0.002" | \$174.17 | \$141.00 |
| Metric | | | | | |
| 52-008-709-0 | 0 - 150mm | Yellow | ± 0.02mm | \$111.23 | \$91.00 |

Prices & Specifications are subject to change without notice.



Outside Vernier Micrometers

0.0001" graduations for higher accuracy.



52-240-001-1



52-215-003-1

Features:

- Graduation: 0.0001"
- Microfine graduations on satin chrome finish and carbide tipped measuring faces
- Diameter of measuring faces: 0.256"
- Flatness: 0.00003"
- Spindle thread hardened, ground and lapped for ultimate accuracy
- Includes a wrench and case
- Sizes over 1"/25mm include a standard

| Order No. | Range | Accuracy | Thimble | List Price | Sale Price |
|--------------|--|------------|----------|------------|-----------------|
| 52-240-001-1 | 0 - 1" | ± 0.00016" | Friction | \$48.24 | \$40.00 |
| 52-240-101-1 | 0 - 1" | ± 0.00016" | Ratchet | \$48.24 | \$40.00 |
| 52-240-002-1 | 1" - 2" | ± 0.00016" | Friction | \$56.10 | \$46.00 |
| 52-240-102-1 | 1" - 2" | ± 0.00016" | Ratchet | \$62.33 | \$52.00 |
| 52-240-003-1 | 2" - 3" | ± 0.0002" | Ratchet | \$65.55 | \$54.00 |
| 52-240-004-1 | 3" - 4" | ± 0.0002" | Ratchet | \$83.77 | \$68.00 |
| 52-240-005-1 | 4" - 5" | ± 0.00024" | Ratchet | \$92.78 | \$76.00 |
| 52-240-006-1 | 5" - 6" | ± 0.00024" | Ratchet | \$101.65 | \$83.00 |
| 52-240-007-1 | 6" - 7" | ± 0.00028" | Ratchet | \$110.52 | \$90.00 |
| 52-240-008-1 | 7" - 8" | ± 0.00028" | Ratchet | \$113.66 | \$93.00 |
| 52-240-009-1 | 8" - 9" | ± 0.00032" | Ratchet | \$129.18 | \$105.00 |
| 52-240-010-1 | 9" - 10" | ± 0.00032" | Ratchet | \$146.50 | \$119.00 |
| 52-240-011-1 | 10" - 11" | ± 0.00036" | Ratchet | \$162.02 | \$132.00 |
| 52-240-012-1 | 11" - 12" | ± 0.00036" | Ratchet | \$203.15 | \$165.00 |
| Sets | | | | | |
| 52-215-003-1 | 0 - 3" with standards and fitted case | | | \$192.35 | \$147.00 |
| 52-215-004-1 | 0 - 4" with standards and fitted case | | | \$275.59 | \$224.00 |
| 52-215-006-1 | 0 - 6" with standards and fitted case | | | \$467.82 | \$379.00 |
| 52-215-012-1 | 0 - 12" with standards and fitted case | | | \$1,418.24 | \$999.00 |
| 52-215-612-1 | 6 - 12" with standards and fitted case | | | \$935.63 | \$758.00 |

Outside Vernier Micrometers

0.001" readings.

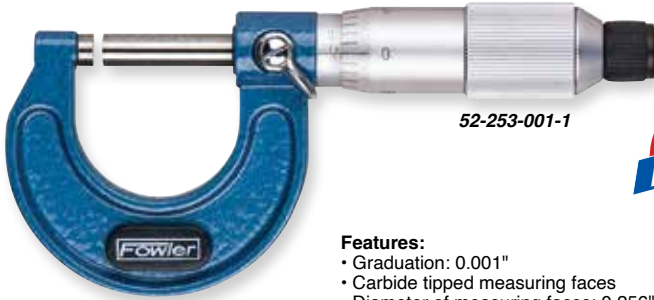

Features:

- Graduation: 0.001"
- Carbide tipped measuring faces
- Diameter of measuring faces: 0.256"
- Anvil & spindle hardened and precision ground with microlap finish on tips
- Sizes over 1"/25mm include a standard

| Order No. | Range | Accuracy | Thimble | List Price | Sale Price |
|--------------|---|----------|----------|------------|-----------------|
| 52-253-001-1 | 0 - 1" | ± 0.001" | Friction | \$40.59 | \$35.00 |
| 52-253-101-1 | 0 - 1" | ± 0.001" | Ratchet | \$40.59 | \$35.00 |
| 52-253-002-1 | 1" - 2" | ± 0.001" | Friction | \$55.21 | \$45.00 |
| 52-253-102-1 | 1" - 2" | ± 0.001" | Ratchet | \$48.24 | \$40.00 |
| 52-253-003-1 | 2" - 3" | ± 0.001" | Ratchet | \$64.21 | \$52.00 |
| 52-253-004-1 | 3" - 4" | ± 0.001" | Ratchet | \$65.55 | \$54.00 |
| 52-253-005-1 | 4" - 5" | ± 0.001" | Ratchet | \$73.20 | \$60.00 |
| 52-253-006-1 | 5" - 6" | ± 0.001" | Ratchet | \$81.97 | \$66.00 |
| Set | | | | | |
| 52-253-600-1 | 0 - 6" Set with standards and fitted case | | | \$372.13 | \$310.00 |

Digit Counter Micrometers

0.001" digit counter.



Features:

- Digital counter reads to 0.001"
- Graduations: 0.0001" (using vernier)
- Microfine graduations on satin chrome
- Carbide tipped measuring faces
- Sizes over 1"/25mm include a standard
- Includes case

| Order No. | Range | Accuracy | List Price | Sale Price |
|--------------|--|----------|------------|-----------------|
| 52-224-001-1 | 0 - 1" | 0.00016" | \$131.76 | \$95.00 |
| 52-224-002-1 | 1" - 2" | 0.00016" | \$138.40 | \$98.00 |
| 52-224-003-1 | 2" - 3" | 0.0002" | \$157.63 | \$106.00 |
| 52-224-004-1 | 3" - 4" | 0.0002" | \$198.53 | \$133.00 |
| Sets | | | | |
| 52-224-103-0 | 0 - 3" set (set finished in grey enamel) | | \$416.85 | \$298.00 |
| 52-224-104-0 | 0 - 4" set (set finished in grey enamel) | | \$589.77 | \$410.00 |
| 52-224-220-0 | 0 - 75mm set (set finished in grey enamel) | | \$486.54 | \$310.00 |

Rapid-Mic Quick-Displacement Electronic Micrometers

Fastest micrometer on the market!



54-815-030-0



54-815-111-0

Features:

- IP67 protected against fluid and dust
- Non-rotating spindle with 0.39"/10mm travel per thimble rotation
- Adjustable measuring force, 5N/10N (54-815-030-0 and 54-815-130-0 only)
- Menu customizable with free software
- **Larger sizes and specialty anvil micrometers also available (special order)**

| Order No. | Range | Accuracy | List Price |
|---------------------------------|--|------------------|------------|
| 54-815-030-0 | 0 - 1.18"/0 - 30mm | 0.00012"/0.003mm | \$657.18 |
| 54-815-060-0 | 1.18" - 2.6"/30 - 66mm | 0.00016"/0.004mm | \$1,191.23 |
| 54-815-100-0 | 2.6" - 4.0"/66 - 102mm | 0.00020"/0.005mm | \$1,299.57 |
| Set | | | |
| 54-815-111-0 | 0 - 4"/0 - 102mm | | \$2,993.72 |
| Bluetooth Models | | | |
| 54-815-130-0 | 0 - 1.18"/0 - 30mm | 0.00012"/0.003mm | \$1,035.50 |
| 54-815-160-0 | 1.18" - 2.6"/30 - 66mm | 0.00016"/0.004mm | \$1,376.95 |
| 54-815-110-0 | 2.6" - 4.0"/66 - 102mm | 0.00020"/0.005mm | \$1,631.28 |
| Bluetooth Set | | | |
| 54-815-112-0 | 0 - 4"/0 - 102mm | | \$4,283.28 |
| Connectivity Cables/Accessories | | | |
| 54-981-713-2 | Sylcom Basic Data Processing Software | | \$851.22 |
| 54-981-724-5 | Sylcom Pro Data Processing Software | | \$2,036.95 |
| 54-115-526-0 | Proximity cable with USB connection | | \$234.54 |
| 54-115-527-0 | Proximity cable with serial connection | | \$227.10 |
| 54-115-246-BT | USB Bluetooth receiver | | \$51.92 |

Electronic Coolant Resistant Micrometers

For basic outside measurements with higher protection.

25.1



54-860-001-1

Features:

- IP54 protected against fluid and dust
- Resolution: 0.00005"/0.001mm
- Carbide measuring faces
- Absolute & incremental modes
- Ratchet thimble
- Automatic switch off
- Free ball attachment included
- Sizes over 1"/25mm include a calibration standard



| Order No. | Range | Accuracy | List Price | Sale Price |
|--------------|-----------------------------|--------------------|------------|-----------------|
| 54-860-001-1 | 0 - 1"/0 - 25mm | ± 0.00016"/0.004mm | \$165.00 | \$126.00 |
| 54-860-002-1 | 1 - 2"/25 - 50mm w/standard | ± 0.00016"/0.004mm | \$190.97 | \$146.00 |
| 54-860-003-1 | 2 - 3"/50 - 75mm w/standard | ± 0.0002"/0.005mm | \$200.24 | \$154.00 |
| Set | | | | |
| 54-860-103-1 | 0 - 3"/0 - 75mm w/standards | | \$542.51 | \$414.00 |

XTRA-VALUE II Electronic Micrometers



54-870-001-0

Features:

- IP40 protected against fluid and dust
- Resolution: 0.00005"/0.001mm
- Carbide measuring faces
- Absolute and incremental modes
- Ratchet thimble
- Free ball attachment included
- Sizes over 1"/25mm include a calibration standard



| Order No. | Range | Accuracy | List Price | Sale Price |
|--------------|-----------------------------|--------------------|------------|-----------------|
| 54-870-001-0 | 0 - 1"/0 - 25mm | ± 0.00016"/0.004mm | \$112.64 | \$88.00 |
| 54-870-002-0 | 1" - 2"/25 - 50mm | ± 0.00016"/0.004mm | \$121.64 | \$99.00 |
| 54-870-003-0 | 2" - 3"/50 - 75mm | ± 0.0002"/0.005mm | \$145.49 | \$125.00 |
| 54-870-004-0 | 3" - 4"/75 - 100mm | ± 0.0002"/0.005mm | \$178.11 | \$145.00 |
| Set | | | | |
| 54-870-103-0 | 0 - 3"/0 - 75mm w/standards | | \$363.74 | \$288.00 |

Micrometers



Electronic IP54 Blade Micrometers



54-860-241-0

Features:

- IP54 protected against fluid and dust
- Blades are 0.030" thick x 0.255" long
- Accuracy: 0.00016"
- Resolution: 0.00005"/0.001mm
- Friction thimble

Order No. 54-860-241-0

Sale \$241.00

List Price \$315.95

Vernier Inch Blade Micrometers



52-246-001-1

Features:

- Anvil & spindle hardened & precision ground with microlap finish on ends
- Non-rotating spindle
- Ratchet thimble
- Blade thickness = 0.030"; blade width = 0.256"; blade penetration = 0.315"
- Sizes over 1" include a standard

| Order No. | Range | Graduation | Accuracy | List Price | Sale Price |
|--------------|---------|------------|----------|------------|-----------------|
| 52-246-001-1 | 0 - 1" | 0.0001" | 0.00016" | \$256.03 | \$231.00 |
| 52-246-002-1 | 1" - 2" | 0.0001" | 0.00016" | \$278.74 | \$252.00 |

Electronic IP65 Thread Micrometers

For accurate pitch diameter measurements.



54-219-001-0



Features:

- IP65 protected against fluid and dust
- Thread range: 64 - 3.5 TPI/0.4 - 7mm
- Accuracy: $\pm 0.00008''/0.002\text{mm}$
- 60° measuring anvils
- Absolute and incremental measuring mode
- Resolution: $0.00005''/0.001\text{mm}$
- Friction thimble

| Order No. | Range | Thread Range | Accuracy | List Price | Safe Price |
|--------------|-------------------|------------------------|--------------------------------|------------|-----------------------|
| 54-219-001-0 | 0 - 1"/0 - 25mm | 64 - 5 TPI/0.4 - 5mm | $\pm 0.00008''/0.002\text{mm}$ | \$304.44 | \$275.00 |
| 54-219-002-0 | 1" - 2"/25 - 50mm | 44 - 3.5 TPI/0.6 - 7mm | $\pm 0.00008''/0.002\text{mm}$ | \$366.51 | \$315.00 |

Vernier Thread Micrometers



52-219-001-1

Features:

- 60° measuring anvils
- Graduation: 0.001"
- Ratchet thimble
- Sizes over 1" include standard

| Order No. | Range | Thread Range | Accuracy | List Price | Safe Price |
|--------------|---------|------------------------|----------|------------|-----------------------|
| 52-219-001-1 | 0 - 1" | 64 - 5 TPI/0.4 - 5mm | 0.00016" | \$139.17 | \$120.00 |
| 52-219-002-1 | 1" - 2" | 44 - 3.5 TPI/0.6 - 7mm | 0.00016" | \$133.86 | \$115.00 |

IP54 Electronic Depth Micrometer



Features:

- IP54 protected against fluid and dust
- Range: 0 - 6"/150mm
- Accuracy: 0.00016"/0.004mm
- Resolution: 0.00005"/0.001mm
- Base surface hardened and microlapped to 0.00008" flatness
- Rod diameter: 0.176"

Order No. 54-225-456-0

Sale \$230.00

List Price \$263.08

Depth Micrometers



52-225-110-0

Features:

- Satin chrome finish
- Base surface hardened and microlapped to 0.00008"
- Ratchet thimble
- Locking clamp
- Rod diameter: 0.176"
- Includes fitted case

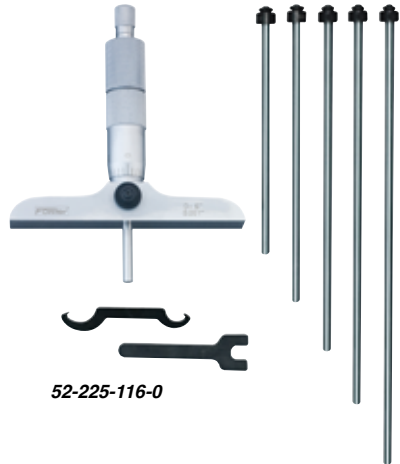

52-225-116-0

| Order No. | Range | Graduation | Accuracy | Base Size | List Price | Sale Price |
|--------------|--------|------------|----------|-----------|------------|-----------------|
| 52-225-110-0 | 0 - 4" | 0.001" | 0.0002" | 2.5" | \$165.31 | \$139.00 |
| 52-225-116-0 | 0 - 6" | 0.001" | 0.0002" | 4" | \$197.98 | \$170.00 |

X-DEPTH 22" 0 - 22" Electronic Depth Gage

Provides rapid electronic measurement of hole depths.

Features:

- 0-1" AGD Group 2
- Accuracy: 0.001"/0.03mm
- Resolution: 0.0005"/0.01mm
- 4" base ground and lapped for flatness
- Rods connect for 22" capacity
- Includes 2 extra points (spline & needle)
- Tolerance function



Order No. 54-125-777-0

Sale \$279.⁰⁰

List Price \$366.69

X-DEPTH 22" 0 - 22" Dial Depth Gage

Features:

- 0 - 1" travel indicator with 4" base
- 0.001" Graduations
- Rods connect together for full 22" capacity
- Satin chrome finish
- Includes 2 extra points for small hole applications; one 0.078" dia. x 1" long and one needle point x 1" long

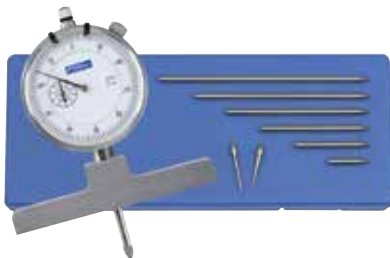

Order No. 52-125-006-1

Sale \$169.⁰⁰

List Price \$235.50

XTRA-VALUE Depth Gage

Features:

- Spring-loaded and hold measurement button for ease-of-use
- Super-large display
- Travel: 0-1"/25mm
- Range: 0-16"/400mm
- Resolution: 0.0005"/0.01mm
(Fractions in 1/64" increments)



Order No. 54-225-555-0

Sale \$69.⁰⁰

List Price \$89.47

Prices & Specifications are subject to change without notice.

29

INDI-X[®] BT Electronic Indicator

Smart Wireless Communication to most phones and tablets

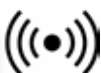

Features:

- Bluetooth compatible to most phones and tablets
- Resolution 0.00005"/0.001mm
- Economical bluetooth option
- Includes lifting hook, ceramic ball contact point, 2 specialty contact points (spline and point), NIST cert., lug and flat backs

Order No. 54-520-285-0

Sale \$167.⁰⁰

List Price \$188.65

INDI-X^{blue} Electronic Indicators

Electronic Indicators

Our most popular electronic indicators.



54-520-255-0



54-520-250-0



54-520-260-0

Features:

- Resolution 0.0005"/0.01mm
- 54-520-260-0 also reads 1/64ths
- 2-1/4" dial face
- Lugback and 3/8" stem mountings
- Tolerance function
- Absolute/incremental reading
- Floating zero



| Order No. | Range | Accuracy | List Price | Sale Price |
|--------------|--------------|-----------------|------------|-----------------|
| 54-520-255-0 | 0.50"/12.5mm | ± 0.001"/0.03mm | \$123.66 | \$95.00 |
| 54-520-250-0 | 1"/25mm | ± 0.001"/0.03mm | \$140.03 | \$107.00 |
| 54-520-260-0 | 1"/25mm | ± 0.001"/0.03mm | \$142.15 | \$109.00 |

Premium Dial Indicators

Smooth, accurate and built tough.

Features:

- AGD Group 2 specifications
- Accuracy meets ANSI standards
- Shockproof gearing
- Jeweled movement
- Tolerance markers
- Solid steel housing
- Carbide contact point
- Includes NIST Certification



52-520-135-0



52-520-105-0



52-520-110-1

| Order No. | Range | Graduation | Reading | Balanced Reading | Dial Color | List Price | Sale Price |
|--------------|-------|------------|---------|------------------|------------|------------|-----------------|
| 52-520-135-0 | 0.05" | 0.0001" | 0 - 10 | 0 - 5 - 0 | White | \$215.83 | \$125.00 |
| 52-520-105-0 | 0.50" | 0.001" | 0 - 100 | 0 - 50 - 0 | White | \$110.92 | \$72.00 |
| 52-520-110-1 | 1" | 0.001" | 0 - 100 | — | Black | \$105.56 | \$76.00 |
| 52-520-110-2 | 1" | 0.001" | 0 - 100 | — | White | \$105.56 | \$76.00 |
| 52-520-120-0 | 2" | 0.001" | 0 - 100 | — | White | \$168.29 | \$121.00 |
| 52-520-129-0 | 1" | 0.0005" | 0 - 50 | 0 - 25 - 0 | White | \$127.60 | \$92.00 |
| 52-520-300-0 | 10mm | 0.01mm | 0 - 100 | 0 - 50 - 0 | White | \$133.92 | \$87.00 |
| 52-520-500-0 | 25mm | 0.01mm | 0 - 100 | 0 - 50 - 0 | White | \$160.65 | \$115.00 |

Inch/Metric Reading Dial Indicator

Features:

- AGD 2 series 2-1/4" dial diameter
- Dial face reads in inch (black) or metric (red)
- Range: 1"/25mm
- Graduation: 0.001"/0.01mm
- Reading: 0-100/0-100-0
- Separated dial for Inch & Metric
- Rotating bezel with clamp
- Lugback included

Order No. 52-530-110-0

Sale \$99.00

List Price \$128.98



X-PROOF[®] IP54 Shockproof Dial Indicator

Features:

- IP54 protected against fluid and dust
- O-ring seal on safety cap
- O-ring protection for bezel and rotating dial
- Continuous reading: 0-100
- Tolerance markers
- AGD Group 2, 2-1/4" dia., 1" Range
- Contact point: 4-48 (3/8" stem)
- Lugback and carbide point

Order No. 52-520-450-0

Sale \$65.00

List Price \$91.57



Electronic Test Indicators

Features:

- Bluetooth connectivity to your phone or tablet
- IP65 protected against fluid and dust
- 4 measuring modes: Min, Max, TIR and Direct
- 4 measuring resolutions - 0.00005"/0.001mm or 0.0005"/0.01mm
- Accuracy: 0.00016" - 0.0004" / 0.003mm - 0.010mm
- 1.7"/43mm dial housing diameter
- Analog scale for reversal point indication
- 54-562-890-BT is capable of interchanging contact point lengths



54-562-777-BT

| Order No. | Range | Contact Point Length | List Price |
|---------------|---------------------------------------|----------------------|------------|
| 54-562-777-BT | 0.030"/0.80mm | 1/2" | \$611.53 |
| 54-562-888-BT | 0.080"/2.0mm | 1-7/16" | \$691.65 |
| 54-562-890-BT | 0.030"/0.80mm 0.080"/2.0mm | 1/2" 1-7/16" | \$861.86 |
| Accessories | | | |
| 54-981-713-2 | Sylcom Basic Data Processing Software | | \$851.22 |
| 54-115-528-0 | USB Power Cable | | \$339.51 |

Horizontal & Vertical Test Indicators

Features:

- Super smooth jeweled movement
- Smooth bezel adjustment for easy zero setting
- Accuracy meets DIN 2270 standards
- 0.080" and 0.120" carbide ball contact points (0.040" steel ball)
- 0.060" range with auto reverse and rev. counter
- Easy to read tilted dial
- 5/32" pivotable stem



52-562-005-0



52-562-001-0



52-562-002-BD

| Order No. | Graduation | Dial Size | Dial Reading | List Price | Sale Price |
|---------------|------------|-----------|--------------|------------|-----------------|
| Horizontal | | | | | |
| 52-562-001-0 | 0.0005" | 1-1/2" | 0 - 15 - 0 | \$150.31 | \$122.00 |
| 52-562-001-BD | 0.0005" | 1-1/2" | 0 - 15 - 0 | \$150.31 | \$122.00 |
| 52-562-002-BD | 0.0005" | 1-1/2" | 0 - 15 - 0 | \$167.00 | \$136.00 |
| 52-562-003-0 | 0.001" | 1" | 0 - 15 - 0 | \$167.00 | \$140.00 |
| 52-562-008-0 | 0.01mm | 38mm | 0 - 40 - 0 | \$167.38 | \$140.00 |
| Vertical | | | | | |
| 52-562-004-0 | 0.0005" | 1-1/2" | 0 - 15 - 0 | \$164.59 | \$118.00 |
| 52-562-005-0 | 0.0005" | 1" | 0 - 15 - 0 | \$182.87 | \$135.00 |

X-TEST Indicator and Accessory Set

X-Test Indicator Features:

- Jeweled movement
- Revolution counter, 0.060" range
- Graduation: 0.0005"
- 5/32" stem with 210° Swivel arc
- Tungsten carbide point: 0.080"

Set Includes:

- X-Test Dial Test Indicator
- Axial support
- Height gage bar with clamp
- Adapter sleeve: 5/32" to 3/8"
- Contact point wrench



Order No. 52-562-100-0

Sale \$176.00

List Price \$206.83

X-PROOF® Water Resistant Indicator Set

For harsh environment.

Magnetic Base Features:

- Fine adjustment
- Base dimensions: 2" x 2-11/32" x 1-13/16"
- Also mounts test indicators with 1/4" post
- 85 lb. pull
- On-Off lever release magnet
- V-base for placing on cylindrical surfaces

Indicator Features:

- Travel: 1"
- Reading: 0.001"
- Accuracy: 0.001"
- Continuous reading: 0 - 100
- Tolerance markers
- Lugback and carbide point



Order No. 52-585-155-0

Sale \$85.00

List Price \$118.48

Fine Adjust Mag Base Set with Mag Back

With **INDI-X blue** Electronic Indicator or AGD White face Indicator

AGD Indicator features:

- AGD Group 2
- Dial diameter: 2-1/4"
- Travel: 1"
- Reading: 0.001"
- Continuous reading: 0 - 100
- Carbide tipped point

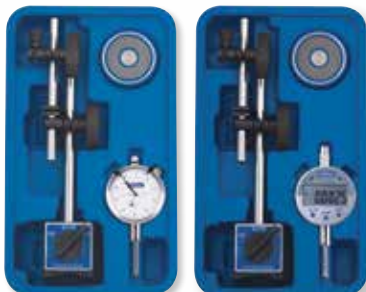

Indi-X blue features:

- Resolution 0.0005"/0.01mm
- 2-1/4" dial face
- Lugback and 3/8" stem mountings
- Tolerance function
- Absolute/incremental reading
- Floating zero

Magnetic Base features:

- 85 lb. pull
- Fine adjustment
- V-bottom base

Magnetic Indicator Back features:

- Use for positioning the indicator on most metal surfaces
- Protective coating

| Order No. | Description | List Price | Sale Price |
|--------------|--|------------|-----------------|
| 54-585-075-0 | Fine Adjust Mag Base Set w/Indi-X blue Indicator Set | \$243.45 | \$175.00 |
| 52-585-125-0 | Fine Adjust Mag Base Set w/AGD Dial Indicator Set | \$179.96 | \$136.00 |

Prices & Specifications are subject to change without notice.



Granite Dial Gage Stand

Sturdy with 0.00005" flatness

Features:

- 6" x 6" x 2" granite base
- Positive lock screw
- Fine adjustment knob for zero setting
- Column height is 8"
- Accepts all lug-back indicators

Order No. 52-580-030-0

Sale \$108.⁰⁰

List Price \$140.53



Deluxe Dial Gage Stand

Holds indicators and probes for thickness and comparative measurements.

Features:

- Quick positioning and adjustment
- Zero settings with fine adjustment
- Fine adjustment of 5/32"
- Holds indicators with stems of 3/8" and 8mm
- Working surface of 3-1/2" x 3-1/2"

Order No. 52-580-015-0

Sale \$340.⁰⁰

List Price \$435.47



Height Transfer & Squareness Gage

Small and compact.

Features:

- Used for a variety of surface plate applications
- Large fine adjustment knob for precise control
- Swivel clamp anchors swivel and indicator for added accuracy
- Rear surface of the gage has a reference surface to place against a master for checking squareness
- Includes a 7.5" post, indicator rod

Indicator and standard shown not included

Order No. 53-620-010-0

Sale \$299.⁰⁰

List Price \$383.13

Articulating Mag Base

Features:

- Fine adjust
- 85 lb. pull
- V-slot on base for mounting on rounded surfaces

Order No. 52-585-008-0

Sale \$99.⁰⁰

List Price \$130.67



Hydraulic Arm Magnetic Base

Heavy duty holding power.

Features:

- Adjusts to virtually any position
- All purpose magnetic base with 180 lbs. of pulling power
- Fine adjustment
- Base can be mounted vertically as well as horizontally,
- V-bottom base allows mounting on cylindrical surfaces

Order No. 52-585-095-0

Sale \$201.⁰⁰

List Price \$280.79



Magnetic Bases

Features:

- 9.5" Height and 85 lb. pull
- Base dimensions are 2" x 2-11/32" x 1-13/16" (50mm x 58.7mm x 46mm)
- Accepts all AGD dial indicators
- V-bottom base allows mounting on cylindrical surfaces
- Mounts test indicators with 1/4" post mount



52-585-005-0



52-585-010-0

Order No.

Description

List Price

Sale Price

52-585-005-0

Magnetic Base

\$69.38

\$50.00

52-585-010-0

Magnetic Base with fine adjustment

\$74.53

\$54.00

Flex Arm Magnetic Bases

Adjustable to any position.

Features:

- All purpose magnetic base with 100 lbs. of pulling power
- Base can be mounted vertically as well as horizontally
- V-bottom base allows mounting on cylindrical surfaces
- Accepts AGD indicators as well as Test Indicators with a stem

Chrome Flex Arm Features:

- Corrosion resistant chrome plated flex arm
- 100 lb pull magnetic base

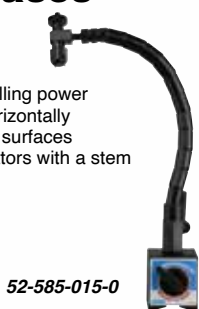

52-585-015-0



52-585-045-0

Order No.

Description

List Price

Sale Price

52-585-015-0

Flex Arm Magnetic Base

\$98.37

\$79.00

52-585-045-0

Chrome Flex Arm Magnetic Base

\$120.89

\$89.00

Clinotronic Plus

Clinotronic Plus is an electronic level with unsurpassed versatility. It is economically priced, uses a specially designed microprocessor and the well-proven Wyler inclination sensor.



**SWISS
MADE**

Features:

- Range of $\pm 45^\circ$, capacity of 0-360°
- Accuracy: ± 3 arc minutes at 45°
- Resolution of 0.01° (selectable)
- Absolute or relative measuring mode selectable by push button
- Seal-tec technology for excellent performance even in difficult environmental conditions
- Interface connection RS-232 is integrated. Special purpose cables available
- No loss of calibration data by power failure
- Response time: value available within 5 seconds
- Repeatability: $< 0.01^\circ$
- Linearity: 3 min. of arc + 1
- Housing: aluminum hard anodized.
- Dimensions: 4 x 3 x 1" (100 x 75 x 30mm)

Order No. 54-635-601-0

Sale \$2,850.⁰⁰

List \$2,999.00

XTRA-VALUE

Digi-Level Electronic Protractor

Provides instant 360° digital inclination display of any angle. Features aluminum housing, with large LCD, reading hold, absolute 0° at sea level.



Features:

- Measuring Range: 360° (4 x 90°)
- Resolution: 0.05°
- Accuracy: $\pm 0.2^\circ$ maximum error
- Repeatability: $\pm 0.05^\circ$
- Dimension: 4" L x 1" W x 3" H
- Uses standard 9V Battery
- Battery Life: up to 250 hrs.
- Operating Temp: -5°C to 50°C (23°F to 122°F)
- Weight: 1.1 lbs.

Order No. 54-422-444-0

Sale \$152.⁰⁰

List \$178.94

Digi Level PLUS+

with smart wireless data



Features:

- IP65 protected against fluid and dust
- Includes a 6" straight edge with beveled edge and 1/32nds graduations
- V's on top and bottom for measuring on cylindrical surfaces
- Embedded magnets on bottom base for vertical and horizontal hold
- Accuracy: $\pm 0.2^\circ$
- Resolution: 0.050°



Order No. 54-422-550-BT

Sale \$158.00

List Price \$186.17

mini-MAG Protractor

The mini-MAG Protractor provides instant 360° digital inclination display of any angle.

Features:

- Accuracy: $\pm 0.2^\circ$
- Resolution: 0.05°
- Embedded magnets
- Display automatically inverts
- Dimensions: 2.375" x 1.375" x 2.375"
- Hold feature
- Battery Life: up to 250 hrs.



Display inverts for easy reading!



Order No. 54-422-450-1

Sale \$92.00

List Price \$113.45

mini-MAG PLUS Protractor

The Mini-Mag PLUS Protractor features a USB rechargeable battery, a backlit display, Tilt% function and IP54 protection against water, oil, and fluids.

Features:

- IP54 protected against fluid and dust
- Auto off after 5 minutes
- Embedded magnets
- Display automatically inverts
- Smaller size: 2.12" x 2.12" x 0.9"
- Measuring range: 360° (4 x 90)
- Accuracy: $\pm 0.2^\circ$
- Resolution: 0.05°
- Hold feature
- Zero function



Order No. 54-422-500-0

Sale \$125.00

List Price \$153.43

Universal Dial Protractor

Get accurate, dependable angular information.



Features:

- Easy to read, each dial revolution equals 10°
- Hardened stainless steel construction throughout
- Includes acute angle attachment
- Blades are beveled 45° on one side and 60° on other side
- Each angle and degree is subdivided into 12 divisions so that each division measures on an interval of 5 minutes
- Positive locking lever
- Accuracy: ± 5 minutes

Order No. 52-440-777-0

Sale \$199.00

List Price \$248.44

Digi-Level PRO Electronic Protractors

Includes embedded magnets for unique measurement areas. On/Off, Zero, Hold and Reverse features.

Features:

- Ideal for fabrication applications
- Embedded 25 lb. pull magnets
- Full, 360° measuring range
- Accuracy: $\pm 0.2^\circ$
- Repeatability: $\pm 0.05^\circ$
- Resolution: 0.1°
- Includes standard 3V lithium battery



54-440-740-1

54-440-775-1

| Order No. | Description | List Price | Sale Price |
|--------------|--------------------|------------|-----------------|
| 54-440-740-1 | 4" Digi-Level PRO | \$123.35 | \$99.00 |
| 54-440-775-1 | 12" Digi-Level PRO | \$129.22 | \$105.00 |

Magnetic Dial Protractor



Features:

- Both flat and "V" mounting with strong built-in magnet
- Punch located at center of "V"
- 1° graduations and accuracy

Order No. 52-450-100-0

Sale \$155.00

List Price \$181.50

X-BLOX V-Block Set

2 each @:

- Dimensions: 1-1/2" L x 1-1/4" W x 1-1/4" H
- Work capacity: Approximately 1"

2 each @:

- Dimensions: 2" L x 1-1/2" W x 1-1/2" H
- Work capacity: 1-1/2"

All feature:

- Surfaces are square and parallel within 0.0005"
- V-grooves are square and parallel with all surfaces within 0.0005"
- Corresponding dimensions for each pair are alike within 0.0005"



Order No. 52-475-500-0

Sale \$144.⁰⁰

List Price \$159.48

1-2-3 & 2-4-6 Blocks

Useful in layout, inspection and grinding work.

Features:

- 23 holes for easy clamping
- Sold in pairs
- Hardened 56 - 60 HRC
- Both styles include 5 threaded holes, 3/8" - 16

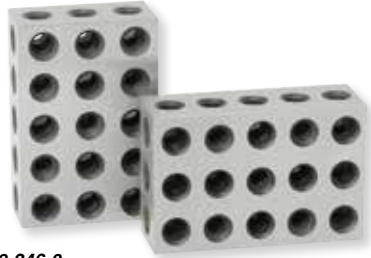

52-439-246-0

| Order No. | Description | Accuracy | List Price | Sale Price |
|--------------|--------------|--------------|------------|-----------------|
| 52-439-031-0 | 1-2-3 Blocks | ± 0.0001"/1" | \$48.66 | \$38.00 |
| 52-439-032-0 | 1-2-3 Blocks | ± 0.0002"/1" | \$101.30 | \$80.00 |
| 52-439-246-0 | 2-4-6 Blocks | ± 0.0003"/1" | \$185.22 | \$142.00 |

Parallel Set

2 thicknesses to choose from!

Features:

- 2 each of 1/2", 5/8", 3/4", 7/8", 1", 1-1/8", 1-1/4", 1-3/8", 1-1/2" & 1-5/8" heights
- Absolute heights are nominal
- Hardness: 50 HRC, 6" length
- 52-437-000-0 paired in height: 0.001"
- 52-437-031-0 paired in height: 0.0001"



Order No. 52-437-000-0

Sale \$231.⁰⁰

List Price \$284.54

Prices & Specifications are subject to change without notice.

39



Bevel Edge Squares

Features:

- Designed for layout & measurement work
- Squares have accurate right angles both inside and outside
- Made from a single piece of fully seasoned tool steel
- Beams and blades are ground and lapped for straightness and parallelism. Blades beveled both edges
- Fully hardened to Rockwell 55C
- Packed in individual carton
- Accuracy = $\frac{0.00008'' + \text{Length (blade)}}{100,000}$

| Order No. | Blade Length | Beam Length | List Price | Sale Price |
|--------------|--------------|-------------|------------|----------------|
| 52-426-004-0 | 3-15/16" | 2-3/4" | \$66.59 | \$55.00 |
| 52-426-005-0 | 4-7/8" | 3-1/8" | \$91.57 | \$65.00 |
| 52-426-006-0 | 6-5/16" | 3-15/16" | \$69.44 | \$56.00 |
| 52-426-008-0 | 7-7/8" | 5-1/8" | \$119.37 | \$89.00 |

Cylindrical Squares

Features:

- Used for checking squares, height gages and other instruments
- Hardened and the ends are lapped to 90° angular accuracy
- 6" cylindrical squares: $\pm 0.0001''$
- 12" cylindrical square: $\pm 0.00015''$



52-750-006-0

52-750-012-0

| Order No. | Description | List Price | Sale Price |
|--------------|-------------|------------|-----------------|
| 52-750-006-0 | 6" | \$269.26 | \$240.00 |
| 52-750-012-0 | 12" | \$384.53 | \$340.00 |

EZ-Sine Bar Set

Simplify sine bar angle set up.

Features:

- Eliminate constant tables for calculation
- Select a riser to obtain the desired angle and you are finished

Sine Bar:

- 5" hardened and precision ground
- 1" body size, top parallel to bottom within 0.0002"

Risers:

- 18 risers of the following angles: 1/2°, 1° thru 15° in 1° increments, 1/4° and 1/2° to measure taper per foot
- Exact constant within 0.001"



Order No. 52-455-050-0

Sale \$199.⁰⁰

List Price \$244.42

SHOP-BLOX® Rectangular Gage Block Sets



53-672-081-0

Features:

- Manufactured to meet Federal Specification ASME B89. 1.9 - 2002 tolerances on length for inch gage blocks
- Certificate of Calibration traceable to NIST
- Tolerances to ± 0.00005 "
- In high-quality fitted wood case

| Order No. | Description | List Price | Sale Price |
|--------------|-------------|------------|-----------------|
| 53-672-036-0 | 36 pieces | \$376.56 | \$269.00 |
| 53-672-081-0 | 81 pieces | \$644.06 | \$461.00 |

CERTIFIED SPACE-BLOX® Gage Block Set

Features:

- 36 blocks
- Certificate of Calibration traceable to NIST
- Tolerances to 0.0001"
- Ground, hardened and tapped
- 4 connection screws included



Order No. 53-680-000-0

Sale \$199.00

List Price \$263.57

Gage Ball Sets

Features:

- Ball gages are ground and lapped chrome steel
- Hardened to 63RC.
- Grade 24 accuracy - AFBMA certificate
- Within .0001" of actual size.
- Sphericity within .000025".
- Surface finish to 1.5 micro inches.
- 52-438-766 Set includes 26 pairs
- Pair sizes in inches: 1/8, 9/64, 5/32, 3/16, 7/32, 1/4, 9/32, 5/16, 11/32, 3/8, 13/32, 7/16, 15/32, 1/2, 17/32, 9/16, 19/32, 5/8, 21/32, 11/16, 23/32, 3/4, 13/16, 7/8, 15/16 and 1"
- 52-438-777 Set includes 25 pairs
- Pair sizes in mm: 1mm through 25mm



| Order No. | Description | List Price | Sale Price |
|--------------|-------------------------------|------------|----------------|
| 52-438-766-0 | 52 piece Gage Ball Set | \$98.24 | \$85.00 |
| 52-438-777-0 | 50 piece Metric Gage Ball Set | \$108.10 | \$85.00 |

Prices & Specifications are subject to change without notice.

COAX-2D 2 Dimensional Coaxial Indicator Sets

Use the 2D Coaxial Set for accurate component centering and positioning in most machining applications. The dial remains stationary during the rotation of the machine spindle.

Features:

- Graduations and revolution counter 0.0005"/0.01mm)
- 3 internal and 3 external feelers; ball dia.: 1/8" (3mm)
- Includes center point feeler and staining arm
- Restraining arm
- Shank: 3/8" dia. x 7/8" long (10mm x 20mm)
- Measuring range: 0.250" (6mm) axis offset
- Speed recommended 800 RPM max.
- Repeatability to within 0.0002" (0.005mm) of true center
- Capacity, depending on feeler is 5/32-12"/4-300mm internal diameter; 0-12"/0-300mm external diameter



52-710-025-0

| Order No. | Description | List Price | Sale Price |
|--------------|-------------------------|------------|-----------------|
| 52-710-025-0 | 2D Coaxial Set - Inch | \$304.04 | \$232.00 |
| 52-710-030-0 | 2D Coaxial Set - Metric | \$293.65 | \$228.00 |

Z-CHECK 65 PLUS+

Z-Axis Tool Setter

Features:

- Supplied with zero reference setting block
- IP65 protected against fluid and dust
- Back light turns on when zero reference is achieved
- 4 magnets embedded into base
- 2" default setting height
- Steel contact surface with 0.0002" flatness
- Resolution: 0.00005"/0.001mm
- Repeatability: 0.00015"/0.004mm
- Accuracy: 0.0001"/0.003mm



Order No. 54-188-200-0

Sale \$115.00

List Price \$131.31

Electronic Edge Finders



Features:

- Six equally spaced light ports provide visibility at any angle
- Edge finder lights instantly when stylus touches work edge
- Repeatability: 0.0002"
- Works on any conductive metal



Along with light indication, model #54-575-650-0 emits an audible "beep" at time of contact

| Order No. | Stylus | Shank | Audible | List Price | Sale Price |
|--------------|--------|-------|---------|------------|-----------------|
| 54-575-600-0 | 0.200" | 1/2" | NO | \$48.60 | \$43.00 |
| 54-575-625-0 | 0.200" | 1/2" | NO | \$153.84 | \$140.00 |
| 54-575-650-0 | 0.400" | 3/4" | YES | \$171.26 | \$155.00 |



Portable Roughness Tester II

Quick, easy roughness testing

The X-Pro Portable Roughness Tester II can be used for various applications by selecting from a variety of accessories including special application probes and a swivel stand.

RS232 data output is available on additional models (contact the Fowler technical department for more information 1-800-788-2353)

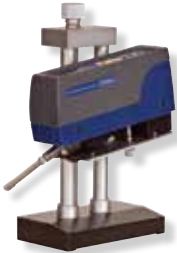

(X-Pro shown with optional stand with swivel)

Features:

- Small, compact size
- 2 selectable parameters: Ra and Rz
- Large LCD display
- Meets ISO and DIN standards
- NIST traceable specimen included
- Uses 9 volt battery (approx. 3000 measurements)
- Special application probes available

X-Pro Portable Roughness Tester II

| Order No. | Description | List Price | Sale Price |
|--------------|---|------------|-------------------|
| 54-410-500-0 | Portable Surface Roughness Tester 0.0004" probe (NIST specifications) | \$2,141.32 | \$1,836.00 |
| 54-410-600-0 | Portable Surface Roughness Tester 0.0002" probe (DIN specifications) | \$2,141.32 | \$1,836.00 |

X-Pro Portable Roughness Tester II Stand with Swivel

| Order No. | Description | List Price | Sale Price |
|--------------|------------------------------|------------|-----------------|
| 54-400-896-0 | Stand with Swivel Attachment | \$515.74 | \$460.00 |

Tool Set 300 Presetter

Used for the quick checking of heights and diameters (radii) of various types of machine tools. Accuracy is guaranteed by a precise steel measuring column and displacement devices in X and Z coordinates utilizing constant measuring force.

Tool Holding Spindle

Tool presetter is supplied with high precision tool pot (Grade 0)

- ISO 50 taper
- Less than 0.00008"/0.002mm concentricity error

Features:

- Measuring range: (X)11.8"/300mm, (Z)15.7"/400mm
- Min/Max functions for TIR readings
- 2 reference indications
- Preset and Tolerance value inputs
- Radius or diameter indication on X-axis display
- Resolution: 0.00005"/0.001mm
- Floating zero function anywhere within axis range
- Carbide measuring insert for durability
- Counter balanced measuring carriage
- Constant measuring force in both axes
- High precision Swiss measuring system



| Order No. | Description | List Price | Sale Price |
|--------------|----------------------------|-------------|-------------------|
| 54-188-300-0 | Tool Presetter | \$11,340.91 | \$9,999.00 |
| 54-121-005-0 | ISO 50/40 Tool Pot Adapter | \$789.41 | \$699.00 |

MICRO Tap Guide



Order No. 52-490-100-0

Sale \$14.00

List Price \$19.78

Features:

- Ensures you start every tap or reamer straight
- Hardened shank diameter: 1/2"
- Hardened tension pin diameter: 3/16"
- Incorporates the use of an adjustable tension spring
- Reversible tension pin for male and female hole centering of tap



12 Piece Swiss Pattern File Set

Features:

Fowler Swiss Pattern Files are precision tools designed for toolmakers, model makers, and part finishers. With tighter tolerances than American files, they excel at removing burrs, truing grooves, cleaning corners, and smoothing small parts.

Order No. 75-130-062-0

Sale \$15.00

List Price \$28.53

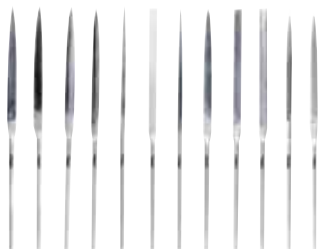

Tool Set

Features:

- Can be operated directly off table or from machine vise
- Aluminum contact face eliminates carbide chipping on cutting tools
- Works on any conductive materials
- Repeatability: .0002"
- Block dimensions: 1" x 2" x 3" (nominal)

Order No. 54-575-750-0

Sale \$55.00

List Price \$127.42



Slowly lower cutting tool toward Tool Set...

...indicator will light up upon contact!

Single Machinist Screw Jack

Features:

- 1-1/2" base
- 3" to 4" adjustable range
- Capacity: 1000 lbs.

Order No. 52-104-001-0

Sale \$8.00

List Price \$10.74



Premium IP54 Shockproof Dial Indicators

Features:

- IP54 protected against fluid and dust
- 1" Range
- Includes both center lug back and flat back
- Steel housing
- Sealed plunger, dust-cap and back plate
- Carbide contact point (4-48 (3/8" stem)
- 0 - 100 dial reading with revolution counter

Order No. 52-520-460-0

Sale \$49.00

List Price \$127.28



Order No. 52-520-465-0

1" Dial Indicator Set

Features:

- Includes 1" indicator and mag base, plus rods, swivel clamp and case
- The 2-1/4" dia., 0.001" indicator features: tolerance hands, lug back and revolution counter

Order No. 52-522-101-0

Sale \$60.00

List Price \$142.76



Extra Long Drive Pin Punches

Features:

- Black nitrate finished. Made of chrome alloy steel. Hardened on both ends
- Knurled finger grip. Length is 8".
- Point sizes: 1/8", 3/16", 1/4", 5/16" and 3/8"

Order No. 52-500-300-0

Sale \$14.00

List Price \$22.20



Fowler

SPECIAL CLEARANCE SALE

Limited Stock!

Vernier Pocket Caliper

4" pocket sized.



Features:

- Range: 4"
- Accuracy: 0.001"
- Graduation: 0.0005"
- Stainless steel construction
- Overall: 6.2"
- Jaw depth: 1.175" and Internal jaw: 0.53"

Order No. 52-057-004-0

Sale \$39.00

List Price \$60.63



X-PROOF 0-22" Dial Depth Gage

Features:

- Graduations: 0.001"
- 0-1" travel indicator
- Rods can be connected together for a full 0-22" capacity
- Includes 2 extra points for small hole applications; one 0.078" dia. x 1" long and one needle point x 1" long, 4-48 thread

Order No. 52-125-007-0

Sale \$89.00

List Price \$284.34

FLIP PLUS Electronic Caliper



Features:

- Display flips 180° with display rotation function for true left handed operation
- Stainless steel frame
- Thumbroll for smooth measuring
- Heavy duty frame is 0.140"/3.5mm thick
- Resolution 0.0005"/0.01mm
- Floating zero

Order No. 54-200-506-0

Sale \$80.00

List Price \$116.02

Left-Handed View



Top View



Dial Height Gage

Features:

- Range: 6"
- Graduations 0.001"
- Fine-adjust for precise control
- Stainless steel construction with satin chrome finish
- Carbide-tipped scriber

Order No. 52-170-006-1

Sale \$99.00

List Price \$125.74

Z-HEIGHT ~~E~~-Jr. Electronic Height Gage

Features:

- Range: 6"/150mm
- Accuracy: 0.001"
- Resolution: 0.0005"/0.01mm
- Hold feature
- ABS/INC Measurement
- Floating zero
- Positive lock
- Carbide scriber

Order No. 54-175-006-0

Sale \$165.00

List Price \$313.27

Mark VI Electronic Indicators with Analog Display



Features:

- Resolution: 0.00005"/0.001mm
- Repeatability: 2µm
- Output: Proximity/Power
- Wide range of functions (MIN/MAX/DELTA,TOL, Factor, Preset, Auto Off, etc)
- Large display, LED tolerance indicators and analog scale



54-530-555-0

| Order No. | Range | List Price |
|--------------|----------------|------------|
| 54-530-535-0 | 0-0.50"/12.5mm | \$776.91 |
| 54-530-555-0 | 0-1"/25mm | \$783.46 |

Sale \$390.00

SPECIAL CLEARANCE SALE

Limited Stock!





Headquarters

780 Dedham Street • Canton • Massachusetts 02021
(800) 788-2353 • (617) 332-4137 fax
sales@fowlerprecision.com • www.fowlerprecision.com

Distribution Center & Showroom

28010 Industry Drive
Valencia, California 91355
(415) 633-5354

Find us on social media

